

EntelliGuard[®] TU Trip Unit

Don't compromise arc flash protection for system reliability.

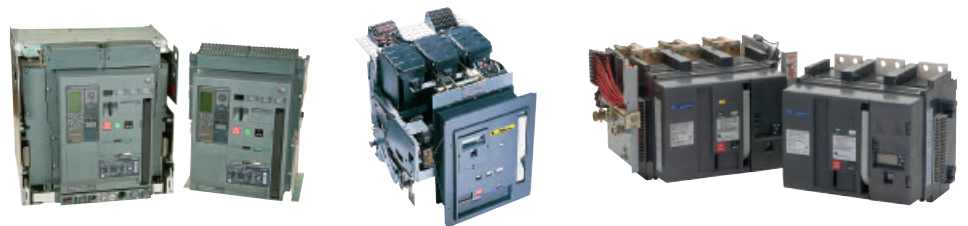

imagination at work

EntelliGuard® TU Trip Units

The new EntelliGuard TU trip unit offers all kinds of solutions for low-voltage switchgear users.



System reliability and protection are the key functions of any trip unit, and the new EntelliGuard TU delivers exactly that, along with the flexibility to address an array of power distribution needs.

The EntelliGuard TU can be used as a replacement for installed MicroVersaTrip® (MVT) and Power+® trip units. The conversion kit replaces those for the current ProTrip™ and MVT for the four previous generations of North American stored energy circuit breakers – Power Break I®, Power Break II, AKR and WavePro®.

It is the standard trip unit for the new EntelliGuard G available worldwide for GE and OEM equipment and for replacements for industrial and commercial switchgear and switchboards provided under UL, CSA, NEMA and IEC standards. The EntelliGuard TU will be common across all new product lines and as a replacement trip unit for installed GE circuit breakers around the world.

Selectivity and arc flash protection – why give up one to get the other?

New capabilities in the EntelliGuard TU deliver selectivity tools not previously available in GE circuit breakers.

You get the flexibility to create the curve shape that best suits your system's need – not a one-size-fits-all-solution. Standard Long Time characteristics exactly mimic the curve of a thermal magnetic circuit breaker and closely match our new line of global Record Plus® molded case circuit breakers. Optional fuse-like Long Time and Ground Fault curves allow optimum selectivity in systems that employ both fused and circuit breaker devices, assuring optimum selectivity and protection simultaneously.

You gain the ability to adjust to exactly what your system needs. A wide range of continuous adjustment Long Time delays ensure the circuit breaker can be exactly dialed in to your selectivity and protection needs.

You can sustain load and protect optimally all the time. Up to 17 Short Time bands allow you to set your circuit breaker to sustain load requirements without slowing your protection more than you absolutely must.

Flexible curve shaping adapts to every need. Multiple Short Time diagonal bands tune your protection to exactly where it needs to be.

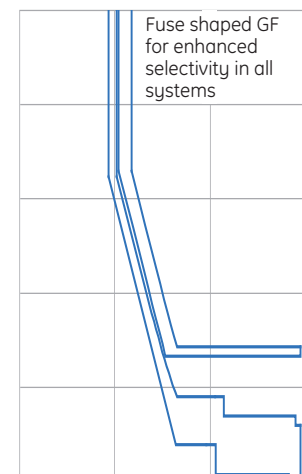
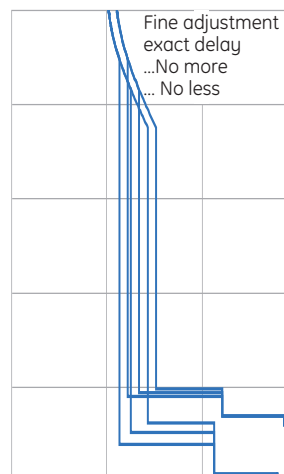
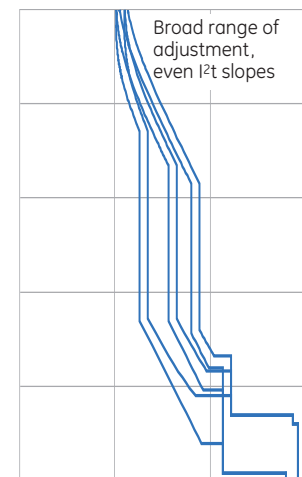
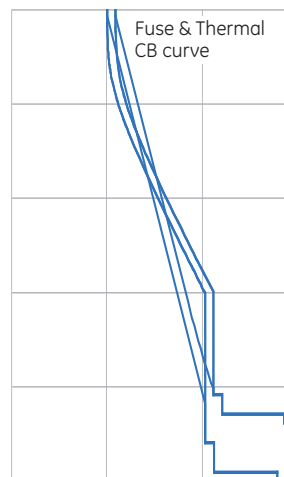

You can provide protection and system reliability simultaneously. Ground fault protection maximizes system protection and system reliability simultaneously with faster time bands, multiple slopes and the ability to coordinate a 1200A ground fault with an 800A circuit breaker – a ratio four times better than in previous generation trip units.

Enjoy instantaneous protection for every need. The industry's most advanced instantaneous protection provides up to three different modes simultaneously.

- Instantaneous pick up is adjustable up to 15 times plug rating on every circuit breaker and, optionally, up to 30 times on some breakers. Intelligent waveform recognition allows the circuit breaker to be set to overlap the instantaneous trip of many GE molded case circuit breakers while maintaining full selectivity and still clearing in less than 3 cycles. Selectivity up to 65, 85 or 100kA is available with instantaneous set at much lower values.
- A separately adjustable fast instantaneous trip is useful for when the circuit must provide the best possible protection and arc flash performance while sustaining normal load.
- An override instantaneous provides fast tripping for the largest bolted fault currents to minimize potential damage.

You get full selectivity and instantaneous clearing at the same time. The industry's most advanced Zone Selective Interlocking system simultaneously provides short time, ground fault and instantaneous selectivity.

A flexible design simplifies maintenance and diagnostics.

GE's exclusive universal spare trip unit allows you to stock one spare that will fit *any* GE circuit breaker in your line-up. The spare trip unit automatically adopts each circuit breaker's particulars upon initial power up, needing only the circuit-specific settings to start protecting your system. This means that, if there's a failure on a Sunday night, you already have the right spare on hand.

EntelliGuard TU universal trip plugs fit any trip unit within the range the sensor accepts. No more needing the exact plug for the specific breaker – any plug with the right current rating will work.

Current metering is standard, and optional power, energy and reactive power metering, harmonics and waveform capture are available.

Flexible serial communications via Modbus RTU or Profibus makes programming easy for any power or building management system.

EntelliGuard TU integrates directly into GE's EnerVista® Power Management System.

Flexible programmable inputs are useful for such various needs as load shedding, ground fault alarm, trip indication and many others.

A large, easy-to-see, backlit LCD screen with battery back up makes it easier to set up the trip unit in such environments as a darkened electrical room.

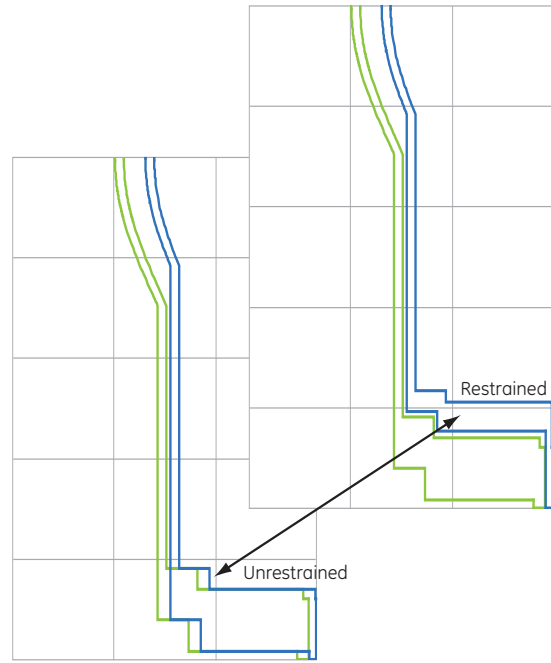

Advanced ZSI allows Instantaneous ZSI to withstand ratings 100kA of selectivity & 3 cycle clearing, simultaneously

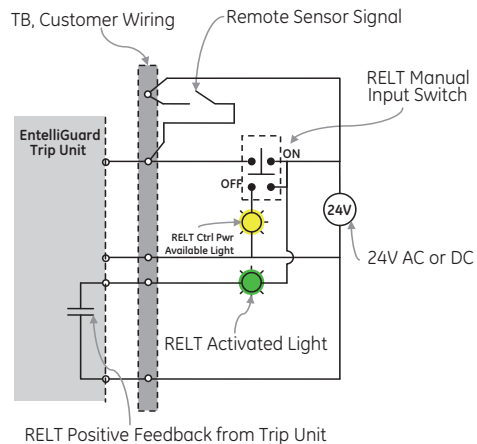
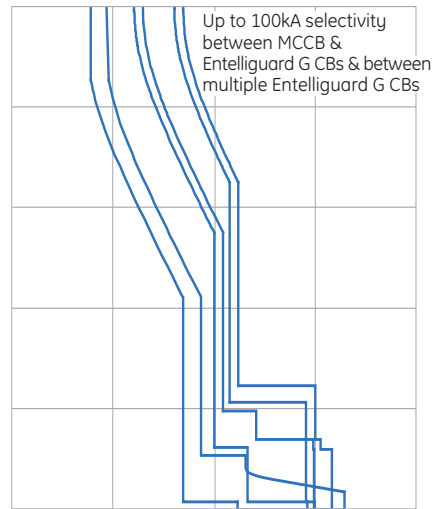

Whatever you need, wherever you need it, the EntelliGuard TU responds.

EntelliGuard TU fits all of GE's existing circuit breaker products for US and international applications, including the Power Break I and Power Break II, AKR, WavePro and the IEC Mpack.

The new EntelliGuard G circuit breaker line employs the same unit in its ANSI, UL and IEC circuit breakers. This new breaker will be available with sensors as low as 400A, adjustable down to under 100A, in UL listed frames rated 6000A.

Built-in flexibility to meet all your needs today. And tomorrow.

GE's EntelliGuard TU is the trip unit with the built-in flexibility required to match your system's needs, whether for optimum safety, optimum system reliability, or both at the same time. Whether you're using all GE circuit breakers or a mixed system of breakers and fusible devices, the EntelliGuard TU will accommodate your needs with minimal compromise and maximum functionality.

EntelliGuard TU meets the highest global standards.

A global product must meet and exceed the toughest standards in the world, and that is what the EntelliGuard TU trip unit does. It meets and surpasses all applicable UL, ANSI, NEMA and IEC standards – not to mention GE's rigorous internal quality standards for a world-class product you can depend on.

Don't compromise arc flash protection for system reliability. Get the EntelliGuard TU. For more information, contact your GE Account Manager or your authorized GE Distributor, or visit www.geelectrical.com/revolution.

GE
41 Woodford Avenue, Plainville, CT 06062
www.geelectrical.com
© 2008 General Electric Company



imagination at work